

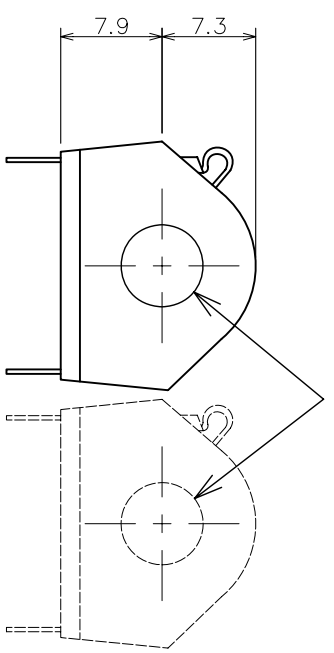

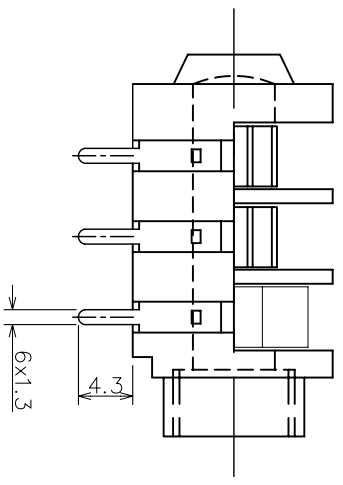

ISOMETRIC VIEW

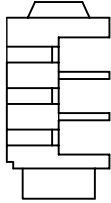

MATERIAL PROPERTIES

Parts	Description	Material	Remark
	Jack Body	Polyamide	Black
	FIBRE WASHER (2 Nos.)	Vulcanized Fibre	Black
	Metal Nut (3/8" x 20TPI)	Brass	Chrome Plated
	Bezel	PP	Black
	Metal Contact	Nickel Silver	Tin Plated

SUPPLY NUTS, BEZELS AND WASHERS AS LOOSE PARTS

DIMENSIONS IN MILLIMETERS
3rd ANGLE PROJECTION
SCALE: N.T.S.

DRAWN PYQ MATERIAL: AS TABLE

TOLERANCES
NO DECIMAL PLACE ± 1.0
1 DECIMAL PLACE ± 0.5
2 DECIMAL PLACES ± 0.1
DIAMETER HOLES ± 0.1
ANGLES ± 1/2 DEGREE
(UNLESS OTHERWISE STATED)

CHECKED PCS FINISH: AS MOULDED

ISSUE	AMEND	DATE
1	1st DRAWN	19/11/14

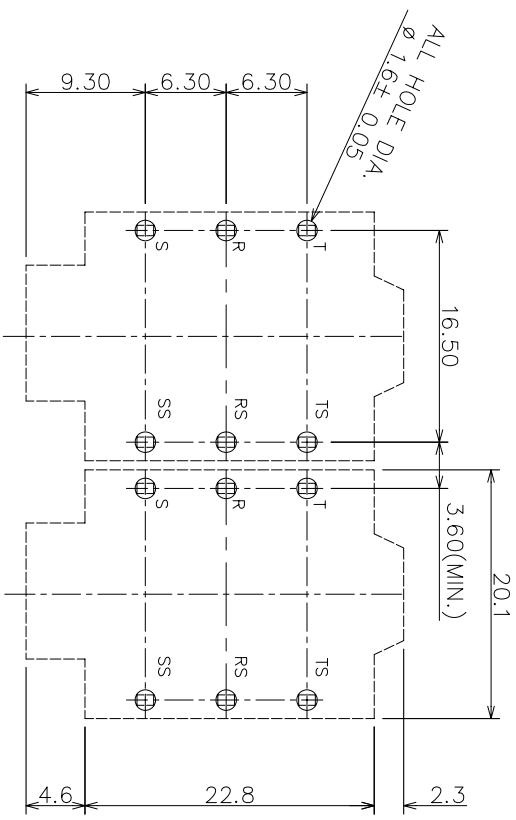

PCB LAYOUT



TITLE: 6.35 PHONE JACK, PCC/MBB

DRWG NO: JC-4390